

XC

Residential Irrigation Controller

Owner's Manual and
Programming Instructions

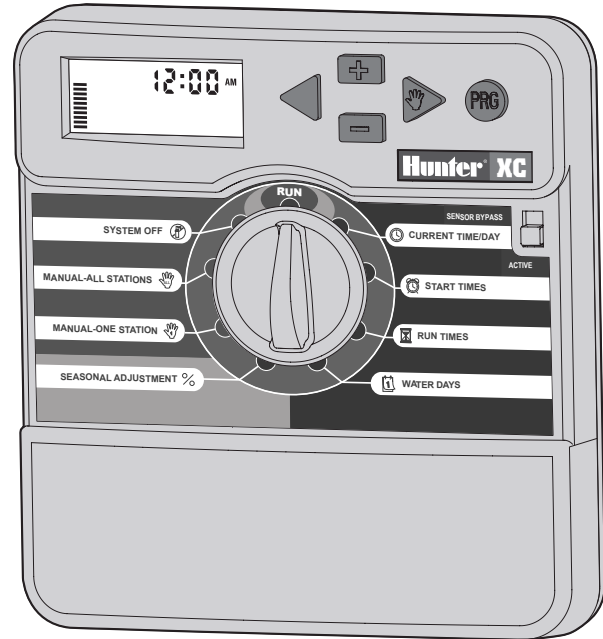





Hunter®





TABLE OF CONTENTS

INSTALLATION

- XC Components 1-2
- Mounting the Controller 3
- Connecting Valves and Transformer..... 3
- Activating the Battery..... 3
- Replacing the Battery..... 4
- Connecting a Master Valve 4
- Connecting a Pump Start Relay 4
- Connecting a Weather Sensor..... 5
- Bypass Weather Sensor 5
- Power Failures..... 5

CONTROLLER PROGRAMMING AND OPERATION

- Watering Schedule Form 6
- Programming the Controller..... 7
 -  Setting the Date and Time..... 7
 -  Setting the Program Start Time 7
 - Eliminating a Program Start Time 8
 -  Setting Station Run Times..... 8
 -  Setting Days to Water 8

- Selecting Specific Days of the Week to Water..... 8
- Selecting Odd or Even Days to Water..... 8
- Selecting Interval Watering 9
- Setting Event Day(s) Off..... 9
-  Automatic Watering 9
-  System Off 9
- Programmable Rain Off..... 9
-  Seasonal Adjustment..... 10
-  Manually Run a Single Station 10
-  Manually Run All Stations..... 10
- One Touch Manual Start and Advance 10
- Advanced Features..... 11
 - Programmable Sensor Override 11
 - Test Program..... 11
 - Hunter Quick Check™..... 11
 - Easy Retrieve™ Program Memory..... 12
 - Programmable Delay Between Stations..... 12
 - Clearing the Controller's Memory/Resetting the Controller 12

TROUBLESHOOTING AND SPECIFICATIONS

- Troubleshooting Guide..... 13-14
- Specifications..... 14
- CE Notice 15

XC COMPONENTS

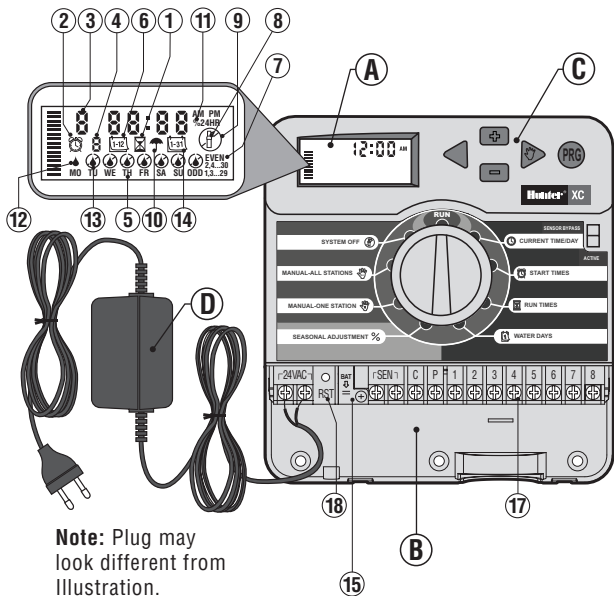



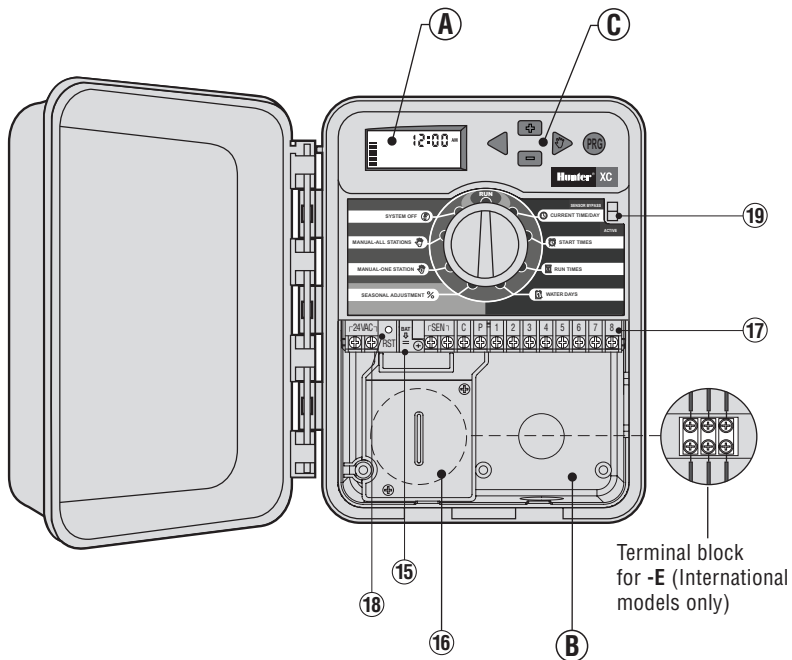





Indoor Model



**Outdoor Model
(Internal Transformer Included)**

A – LCD Display

-  **Run Times** – Allows user to set each valve station run time from 1 minute to 4 hours.
-  **Start Times** – Allows 1 to 4 start times to be set in each program.
- Station Number** – Indicates currently selected station number.
- Program Designator** – Identifies program (A, B, or C) in use.
- Day of the Week** – Identifies day of the week
-  **Interval Watering** – Identifies month when programming current date.
- Odd/Even Watering** – Identifies if Odd or Even watering has been selected.
- Flashing Sprinkler** – Indicates that watering is taking place.
-  **System Off** – Allows user to discontinue all programs and watering. Also allows the user to set the programmable "rain off" which stops watering for a period from 1 to 7 days.
-  **Umbrella** – Indicates that the rain sensor is active.
- % Seasonal Adjustment** – Allows the user to make run time changes according to the seasons without reprogramming the controller. Bars on the left allow quick visual reference to the seasonal adjustment percentage.
-  **Rain Drop** – Indicates watering will occur on the selected day.
-  **Crossed Rain Drop** – Indicates the watering will NOT occur on the selected day.
-  **Calendar** – Indicates interval watering schedule has been programmed. Icon also appears when programming the current day.





B – Wiring Compartment

- Lithium Battery** – The replaceable lithium battery (included) allows the controller to be programmed in the absence of AC power. In addition, the battery will provide power for backup timekeeping in the event of a power outage.
- Internal Junction Box** – Junction box in outdoor models for making AC power connections.

17. Terminal Strip – Use to attach transformer, sensor, and valve wires from their source to the controller.

18. Reset Button – Use to reset the controller.

C – Control Buttons

-  **Button** – Increases the selected item flashing in the display.
-  **Button** – Decreases the selected item flashing in the display.
-  **Button** – Returns selected flashing display to previous item.
-  **Button** – Advances the selected flashing display to the next item.
-  **Button** – Selects program A, B or C for different watering zone requirements.

19. Sensor Bypass Switch.

Dial Settings

Run – Normal dial position for all controller automatic and manual operation.

 **Current Time/Day** – Allows current day and clock time to be set.

 **Start Times** – Allows 1 to 4 start times to be set in each program.

 **Run Times** – Allows user to set each valve station run time from 1 minute to 4 hours.

 **Water Days** – Allows the user to select interval days to water.

% Seasonal Adjustment – Allows user to make run time changes according to the seasons without reprogramming the controller. Bars on the left allow quick visual reference to the seasonal adjustment percentage.

 **Manual-One Station** – Allows user to activate a one-time watering of a single valve.

 **Manual-All Stations** – Allows user to activate a one-time watering of all valve stations or a few selected stations.

 **System Off** – Allows user to discontinue all programs and watering. Also allows the user to set the programmable rain off which stops watering for a period from 1 to 7 days.

D – External Transformer (Indoor Model only)

A plug in transformer is provided to supply AC power to the controller.

MOUNTING THE CONTROLLER TO WALL



NOTE: The indoor XC is not waterproof or weather resistant, and must be installed indoors or in a protected area.

1. Secure one screw into the wall. Install screw anchors if attaching to drywall or masonry wall.
2. Slide the keyhole on top of the controller over the screw.
3. Secure the controller in place by installing screws in the holes below the terminal strip.



Do not plug transformer into power source until controller is mounted and all valve wiring has been connected.

CONNECTING VALVES AND TRANSFORMER

Installation of the XC should only be done by trained personnel.

1. Route valve wires between the control valve location and controller.
2. At valves, attach a common wire to either solenoid wire on all valves. This is most commonly a white colored wire. Attach a separate control wire to the remaining wire of each valve. All wire connections should be done using waterproof connectors.
3. Route the valve wires through the conduit. Attach the conduit through the bottom right side of the controller.

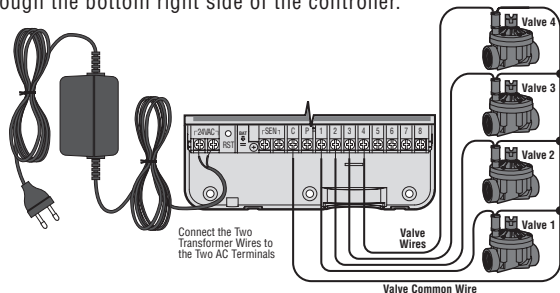

4. Secure the white valve common wire to the C (Common) screw on the terminal strip. Attach each of the individual valve control wires to the appropriate station terminals and tighten their screws.
5. **Indoor Models:** route the transformer cable through the hole on the left side of the controller and connect the wires to the two screws marked 24VAC.

Outdoor Models: transformer wires are already connected to the AC terminals so all that is required is to connect primary power to the junction box (see below).

E – High Voltage Wiring (Outdoor Model only)



NOTE: XC outdoor models are water and weather resistant. Connecting the outdoor XC to primary AC power should only be done by a licensed electrician following all local codes. Improper installation could result in shock or fire hazard.

1. Route AC power cable and conduit through the ½" (13mm) conduit opening on the left side bottom of the cabinet.
2. Connect one wire to each of the two wires inside the junction box. The ground wire should be connected to the green wire. Wire nuts are provided to make these connections. **Note: For –E models only:** Connect the wires to the AC terminal block inside the junction box. AC supply wires must be 14 AWG (1.85 mm) or larger with appropriate circuit breaker for the wire size. A switch or circuit-breaker shall be included in the building installation (in close proximity to the controller, within easy reach of the operator) and marked as the disconnecting device for the equipment.
3. Replace the junction box cover.

ACTIVATING THE BATTERY

After installing your XC make sure to remove the battery contact insulator to allow the XC to keep time in the event of a power outage.



REPLACING THE BATTERY

A high-energy lithium battery is included with your XC controller. The battery allows the user to remotely program the controller without connecting AC power. It is also used to keep the current time and day during power outage conditions. To replace the battery:

1. Remove the screw from the battery holder.
2. Slide the battery holder down to access the battery.
3. Remove and replace the new battery into the battery holder and reinstall the battery holder.

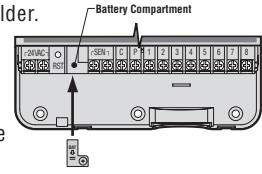
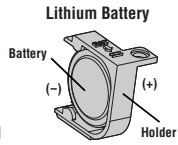

NOTE: This positive(+) side of the battery should face the inside of the battery holder.

Battery type: CR2032 3V

CONNECTING A MASTER VALVE

NOTE: Complete this section only if you have a master valve installed in your irrigation system. A master valve is a "normally closed" valve installed at the supply point of the main line that opens only when the controller initiates a watering program.

1. At the Master Valve, attach the common wire to either solenoid wire of the valve. Attach a separate control wire to the remaining solenoid wire.

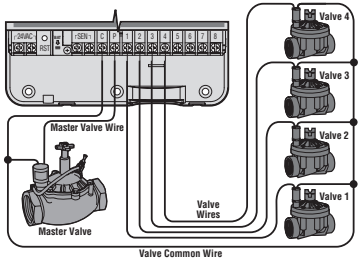

2. The common wire should be attached to the C terminal inside the controller. The other wire coming from the master valve should be attached to the P terminal inside the controller. Tighten each terminal screw.

CONNECTING A PUMP START RELAY

NOTE: Complete this section only if you have a pump start relay installed. A pump start relay is a device that uses a signal from the controller to actuate a separate electrical circuit to energize a pump to provide water to your system.

The controller should be mounted at least a 15 ft (4.5 m) away from both the pump start relay and pump to minimize any potential electrical interference.

1. Route a pair of wires from the pump relay into the controller.
2. Connect a common wire to the C (Common) terminal inside the controller and connect the remaining wire from the pump start relay to the P terminal.

Relay holding current draw must not exceed .30 amps. Do not connect the controller directly to the pump or damage to the controller will result.

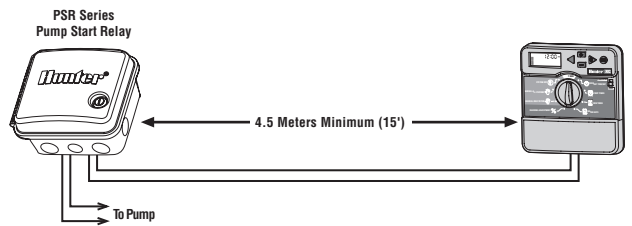

CONNECTING A WEATHER SENSOR-

A Hunter weather sensor or other micro-switch type weather sensors can be connected to the XC. The purpose of this sensor is to stop automatic watering when weather conditions dictate.

1. **Remove the metal jumper plate** that is attached across the two SEN terminals inside the controller.
2. Connect one wire to one SEN terminal and the other wire to the other SEN terminal.

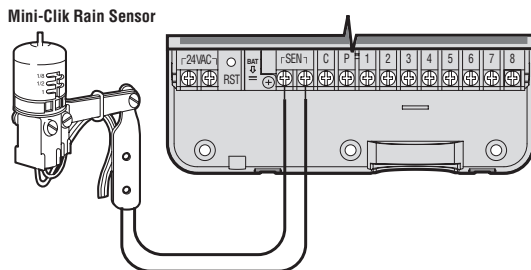

When the weather sensor has deactivated automatic watering, the OFF, and ☂ icon will appear on the display.



Testing the Weather Sensor

The XC provides simplified testing of a rain sensor when the sensor is wired into the sensor circuit. You can manually test proper operation of the rain sensor by running a **MANUAL ALL STATIONS** cycle or by activating the system using the **One Touch MANUAL START** (see page 10). During the Manual cycle, pressing the test button on the Mini-Clik® will interrupt watering.

Manually Bypassing the Weather Sensor

If the rain sensor is interrupting irrigation you can bypass it by using the bypass switch on the front of the controller. Slide the switch to the **SENSOR BYPASS** position to disable the rain sensor from the system to allow for controller operation. You can also bypass the weather sensor for manual operation by using the **MANUAL – ONE STATION** function.



POWER FAILURES

Due to the possibility of power failures, the controller has non-volatile memory. Programmed information will never be lost due to a power outage. The lithium battery will keep the correct time without AC power. Normal watering will resume when AC power is restored.

WATERING SCHEDULE

HUNTER XC		PROGRAM A							PROGRAM B							PROGRAM C									
DAY OF THE WEEK		MO	TU	WE	TH	FR	SA	SU																	
ODD/EVEN OR INTERVAL																									
PROGRAM START TIMES		1																							
		2																							
		3																							
		4																							
STATION	LOCATION	STATION RUN TIME							STATION RUN TIME							STATION RUN TIME									
1																									
2																									
3																									
4																									
5																									
6																									
NOTES:																									

PROGRAMMING THE CONTROLLER



The XC display shows the time and day when the controller is idle. The display changes when the dial is rotated to indicate the specific programming information to enter. When programming, the flashing portion of the display can be changed by pressing the **+** or **-** buttons. To change something that is not flashing, press the **◀** or **▶** buttons until the desired field is flashing.

Three programs A, B, and C, each with the ability to have four daily start times, permit plants with different watering requirements to be separated on different day schedules.



NOTE: A basic programming rule is that whatever symbol or character is flashing will be the item programmed. For instance, if the hour is flashing when setting the time, the hour can be changed or programmed. For illustration purposes in this manual, flashing characters are in GRAY type.

Setting the Date and Time

1. Turn the dial to the **CURRENT TIME/DAY** position.
2. The current year will be flashing. Use the **+** or **-** buttons to change the year. After setting the year, press the **▶** button to proceed to setting the month.
3. The month and day will be in the display. The month will be flashing and the  icon will be displayed. Use the **+** or **-** buttons to change the month. Press the **▶** button to proceed to setting the day.
4. The day will be flashing and the  icon will be displayed. Use the **+** or **-** buttons to change the day. Press the **▶** button to proceed to setting the time.

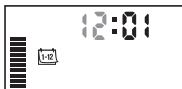

5. The time will be displayed. Use the **+** and **-** buttons to select AM, PM, or 24 hour. Press the **▶** button to move to hours. Hours will be flashing. Use the **+** and **-** buttons to change the hour shown on the display. Press the **▶** button to move to minute. Minutes will be flashing. Use the **+** and **-** buttons to change the minutes shown on the display. The date, day, and time have now been set.



Setting the Program Start Time(s)

1. Turn the dial to the **START TIMES** position.
2. The factory preset is set on program A. If necessary, you can select program B, or C by pressing the **PRG** button.
3. Use the **+** or **-** button to change the start time. (The start times advance in 15 minute increments).
4. Press the **▶** button to add an additional start time, or **PRG** button for the next program.



NOTE: One start time will activate all stations sequentially in that program. This eliminates the need to enter each station's start time. Multiple start times in a program can be used for separate morning, afternoon, or evening watering cycles. Start times may be entered in any order. The XC will automatically sort them.

Eliminating a Program Start Time

With the dial set to **START TIMES** position, push the **+** or **-** button until you reach 12:00 AM (Midnight). From here push the **OK** button once to reach the OFF position.

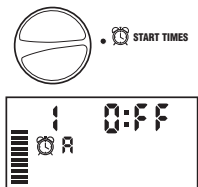

Setting Station Run Times

1. Turn the dial to **Run Times** position.
2. The display will show the last program selected (A, B, or C), the station number selected, **⌚** icon, and the station will be flashing. You can switch to another program by pressing the **PROG** button.
3. Use the **+** or **-** button to change the station run time on the display. You can set the run times from 0 to 4 hours.
4. Press the **▶** button to advance to the next station.



Setting Days To Water

1. Turn the dial to the **WATER DAYS** position.
2. The display will show the last program selected (A, B, or C). You can switch to another program by pressing the **PROG** button.
3. The controller will display the seven days of the week (MO, TU, WE, TH, FR, SA, SU). Each day will have a **☀** icon or a **☾** icon above the day. The **☀** icon would represent an “On” water day, while a **☾** icon would represent an “Off” watering day.



Selecting Specific Days of the Week to Water

1. With the **☀** cursor on a specific day (the cursor will always start with MO), press the **+** button to activate a particular day of the week to water. Press the **OK** button to cancel watering for that day. After pressing a button the cursor automatically advances to the next day.
2. Repeat step 1 until all desired days have been selected. The selected days will show a **☀** to indicate their status is ON. The last **☀** is the last day of watering for that program.



Selecting Odd or Even Days to Water

This feature uses numbered day(s) of the month for watering instead of specific days of the week (odd days: 1st, 3rd, 5th, etc.; even days: 2nd, 4th, 6th, etc.).

1. With the **☀** cursor on Su press the **▶** button once. The **☀** icon and odd will be displayed.
2. If odd day watering is desired, turn the dial back to the run position.
3. If even day watering is desired, press the **▶** button once. The **☀** icon and **EVEN** will be displayed. You can move back and forth from **ODD** to **EVEN** by pressing the **◀** and **▶** buttons.



Odd Day Watering



Even Day Watering





NOTE: The 31st of any month and February 29th are always “off” days if Odd watering is selected.

PROGRAMMING THE CONTROLLER (cont.)

Selecting Interval Watering

With this option you can select interval watering from 1 to 31 days.







1. With the cursor on **EVEN**, press the  button once and the  icon will appear and a 1 flashing in the display. Interval watering schedule appears on the display.
2. Press the  or  button to select the number of days between watering days (from 1 to 31 days). This is called the interval.

The controller will water the selected program at the next start time and will then water at the interval programmed.

Setting Event Day(s) Off

The XC allows you to program a No Water Day(s). This feature is useful to inhibit watering on specific day(s). For example, if you always mow the lawn on Saturdays, you would designate Saturday as a **No Water Day** so that you are not mowing wet grass.

1. Turn the dial to the **WATER DAYS** position.
2. Enter an interval watering schedule as described on page 8.
3. Press the  button to scroll to the **No Water Days** at the bottom of the display. **MO** will be flashing
4. Use the  button until the cursor is at the day of the week you wish to set as a No Water Day.
5. Press the  button to set this day as a no water day. The  will illuminate over this day.
6. Repeat steps 4 and 5 until all desired event day(s) are off.



NOTE: You also have the option in the interval watering schedule to program Odd or Even days off

Automatic Watering

After programming the XC, set the dial to the **RUN** position to enable automatic execution of all selected watering programs and start times.



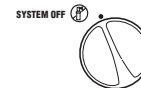

System Off

Valves currently watering will be shut off after the dial is turned to the **SYSTEM OFF** position for two seconds. All active programs are discontinued and watering is stopped. To return the controller to normal automatic operation, simply return the dial to the **RUN** position.



Programmable Rain Off

This feature permits the user to stop all programmed waterings for a designated period from 1 to 7 days. At the end of the programmed rain off period, the controller will resume normal automatic operation.



1. Turn the dial to the **SYSTEM OFF** position. Wait for **OFF** to be displayed.
2. Press the  button as many times as needed to set the number of days off (up to 7 days).
3. Turn the dial back to the **RUN** position at which **OFF**, a **number**, the  and  icons will be displayed.

The days off remaining will decrease at midnight each day. When it goes to zero, the display will show normal time of day and normal irrigation will resume at the next scheduled start time.



Seasonal Adjustment %

Seasonal Adjust is used to make global run time changes without re-programming the entire controller. To use the seasonal adjustment feature:

1. Turn the dial to the **SEASONAL ADJUSTMENT** position. 
2. The display will now show a flashing number followed by a %, as well as the bar graph which always remains on the display. Press the **+** or **-** button to adjust the percentage of the seasonal adjustment. Each bar on the graph represents 10%. This feature can adjust the controller from 10% to 150% of the original program. 

To view the adjusted run times, simply turn the dial to the **RUN TIMES** position, the displayed run time will be updated accordingly as the seasonal adjustment is made.

NOTE: The controller should always be initially programmed in the 100% position.

Manually Run a Single Station

1. Turn dial to **MANUAL – ONE STATION** position. 
2. Station run time will flash in the display. Use the **▶** button to move to the desired station. You may use the **+** or **-** button to select the amount of time for a station to water.
3. Turn the dial clockwise to the **RUN** position to run the station (only the designated station will water, then the controller will return to automatic mode with no change to the previously set program). Also see **One Touch Start and Advance**.

Manually Run All Stations

1. Turn dial to **MANUAL – ALL STATIONS** position. 
2. Select program A, B, or C by pressing the **PRG** button.
3. Station run time will flash in the display. Use the **+** or **-** button to select the amount of time for a station to water if different from the run time displayed.
4. Use the **▶** button to move to the next station.
5. Repeat steps 3 and 4 to customize each station.
6. Press the **▶** button until you reach the station at which you would like watering to begin.

Turn the dial clockwise to the **RUN** position (the controller will water the entire program beginning with the station number last left in the display, then return to the automatic mode with no change in the previously set program).

One Touch Manual Start and Advance







You can also activate all stations to water without using the dial.

1. Hold down the **▶** button for 2 seconds.
2. This feature automatically defaults to program A. You can select program B or C by pressing the **PRG** button.
3. The station number will be flashing. Press the **▶** button to scroll through the stations and use the **+** or **-** button to adjust station run times. (If no buttons are pressed for a few seconds during step 2 or 3, the controller will automatically begin watering).
4. Press the **▶** button scroll to the station you wish to begin with. After a 2 second pause, the program will begin. At any time during the manual cycle, you can use the **◀** or **▶** buttons to navigate from station to station manually.

ADVANCED FEATURES



Programmable Sensor Override

The XC allows the user to program the controller so that the sensor disables watering on only desired stations. For example, patio gardens that have pots under overhangs and roofs may not receive water when it rains and will continue to need to be watered during periods of rain. To program sensor override:

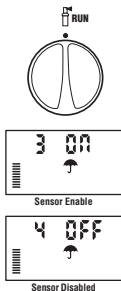
1. Turn the dial to the **RUN** position.
2. Press and hold the  button down while turning the dial to **START TIMES** position.
3. Release the  button. At this point, the display will show the station number, ON, and the  icon, will be flashing.
4. Press the  or  button to enable or disable the sensor for the station shown.
ON = Sensor enabled (will suspend irrigation)
OFF = Sensor disabled (will allow watering)
5. Use the  or  buttons to scroll to the next station that you would like to program the sensor override.





NOTE: The controller default is for the sensor to disable watering on all zones when rain occurs.

When the XC receives an input from the sensor to disable watering, the display will indicate those stations that have been programmed to override the sensor. A station that is running in the sensor override mode will flash the  and  icons alternately.







Test Program of All Stations

The XC allows the user a simplified method for running a test program. This feature will operate each station in numerical sequence, from the lowest to the highest.

1. With the dial in the **RUN** position, press and hold the  button. The station number will be displayed and the time will be flashing.
2. Use the  or  buttons to set the run time from 1 to 15 minutes. The run time needs to be entered only once.
3. After a 2 second pause, the test program will start.

Hunter Quick Check™ Diagnostics

This feature allows you to quickly diagnose wiring problems with your controller. Instead of having to check each field wiring circuit for potential problems, you can use the Hunter Quick Check circuit test procedure. To initiate the Quick Check test procedure:

1. Press the , , , and  buttons simultaneously. In the standby mode, the LCD will display all segments.
2. Press the  button once to begin the Quick Check procedure. Within seconds, the system searches all stations for detecting any circuit problems. When a field wiring short is detected, an ERR symbol preceded by the station number will momentarily flash on the display. After the Quick Check completes running the circuit diagnostic procedure, the controller returns to the automatic watering mode.

Easy Retrieve™ Program Memory

The XC is capable of saving the preferred watering program into memory for retrieval at a later time. This feature allows for a quick way of resetting the controller to the original programmed watering schedule.

To save the program into the memory

1. With the dial in the **RUN** position, press and hold the **+** and **PRG** buttons for 5 seconds. The display will scroll three segments from left to right across the display indicating the program is being saved into memory.
2. Release the **+** and **PRG** buttons.

To retrieve a program that was previously saved into memory.

1. With the dial in the **RUN** position, press and hold the **-** and **PRG** buttons for 5 seconds. The display will scroll three segments from right to left across the display indicating the program is being saved into memory.
2. Release the **-** and **PRG** buttons.

Programmable Delay Between Stations

This feature allows the user to insert a delay between stations between when one station turns off and the next one turns on.



1. Start with the dial in the **RUN** position.
2. Press and hold the **-** button down while turning the dial to the **RUN TIMES** position.
3. Release the **-** button. At this point the display will show a delay time for all stations in seconds, which will be flashing.
4. Press the **+** or **-** buttons to increase or decrease the delay time between 0 and 4 hours.
5. Return the dial to the **RUN** position.

Clearing the Controller's Memory/Resetting the Controller



If you feel you have misprogrammed the controller, there is a process that will reset the memory to the factory defaults and erase all programs and data that have been entered into the controller.

1. Press and hold down the **-**, **▶**, and **PRG** buttons.
2. Press and release the reset button in the lower wiring compartment.
3. Wait 2 seconds and release the **-**, **▶**, and **PRG** buttons. The display should now show 12:00 am. All the memory has been cleared and the controller may now be reprogrammed.

TROUBLESHOOTING GUIDE

PROBLEM	CAUSES	SOLUTIONS
The controller is continuously watering	Too many start times have been programmed.	Only one start time is necessary to activate a program. (refer to Setting Watering Start Times on page 7).
There is no display	Check AC power wiring.	Correct any errors.
The display reads “No AC”	There is no AC power present (the controller is not receiving any power).	Check to see if the transformer is properly installed.
Display reads “Off,   ”	The rain sensor is interrupting irrigation or the sensor jumper has been removed.	Slide the rain sensor bypass switch to the BYPASS position to bypass the rain sensor circuit, or reinstall the jumper.
Rain sensor will not shut off the system	Defective rain sensor. Jumper was not removed when sensor was installed. Stations have been programmed to override the sensor.	Verify operation of rain sensor and proper wiring Remove jumper from the sensor terminals. Reprogram the sensor override to enable the sensor (see page 10).
Frozen display, or showing incorrect information	Power surge.	Reset the controller per page 11 “Clearing Controller Memory/Resetting the Controller”.
Display shows “ERR” with a number (1-8).	Short in valve wiring circuit, or faulty solenoid on the station number indicated.	Check wire circuit or solenoid for the valve number indicated. Repair short or replace solenoid. Press any button to clear the “ERR” from the display.
Display shows “P ERR”	Faulty pump relay or master valve wiring Incompatible or defective relay or solenoid Under sized wire to the pump relay or master valve.	Check wiring to relay or master valve solenoid. Press any button to clear the “P ERR” from the display. Check electrical specification for the pump relay. Do not exceed controller’s electrical rating. Replace if defective. Replace wire with larger gauge wire.

TROUBLESHOOTING GUIDE (cont.)

PROBLEM	CAUSES	SOLUTIONS
Display shows a station is running but the  and  icons are flashing	The sensor is interrupting irrigation, however the station has been programmed to override the sensor.	Check the sensor override status (see page 10)
Automatic irrigation does not start at the start time and controller is not in the System Off mode	AM/PM of time of day not set correctly. AM/PM of start time not set correctly. Start Time is disabled (set for Off). Controller is not receiving AC power	Correct AM/PM of time of day Correct AM/PM of start time See Setting Start Times (pg 7) Check AC power connections.

SPECIFICATIONS

Operating Specifications

- Station Run Times: 0 to 4 hours in 1-minute increments.
- 3 Independent Watering Programs.
- Start Times: 4 per day per program for up to 12 daily starts.
- Watering Schedule: 365-day calendar, interval watering, odd/even watering.
- AM/PM, 24-hour clock.
- Simple manual operation.
- Sensor override by station.
- Programmable rain delay (1 to 7 days).
- Seasonal adjustment (10% to 150%).
- Sensor bypass switch.
- XC-x00i for indoor use. XC-x00 for outdoor use.
- Sea level to 2000m at 0-50°C.

Electrical Specifications

- Transformer input 120VAC $\pm 10\%$ 60 Hz (230VAC $\pm 10\%$ 50/60 Hz International Models).
- Transformer Output: 24VAC 1.0 amp.
- Station Output: .56 amps per station.
- Maximum Output: .84 amps (includes master valve).
- Battery: 3V Lithium (included) used for remote programming and backup timekeeping. Use GR2032 3-volt.
- Electronic short circuit protection.
- Non-volatile memory for program data.
- UL Listed.
- Model XC-x00 has an IP2X Rating.
- Clean only with a cloth dampened with mild soap and water.

Explanation of Symbols

~ = AC



= Consult Documentation



= Hazardous Voltages Present



= Ground

CERTIFICATE OF CONFORMITY TO EUROPEAN DIRECTIVES

Hunter Industries declares that the irrigation controller Model XC complies with the standards of the European Directives of “electromagnetic compatibility” 87/336/EEC and “low voltage” 73/23/EEC.

Project Engineer



This product should not be used for anything other than what is described in this document. This product should only be serviced by trained and authorized personnel.

FCC part 15:

This equipment has been tested and found to comply with the limits for a Class B digital device, pursuant to part 15 of the FCC Rules. These limits are designed to provide reasonable protection against harmful interference in a residential installation. This equipment generates, uses and can radiate radio frequency energy and, if not installed and used in accordance with the instructions, may cause harmful interference to radio communications. However, there is no guarantee that interference will not occur in a particular installation. If this equipment does cause harmful interference to radio or television reception, which can be determined by turning the equipment off and on, the user is encouraged to try to correct the interference by one or more of the following measures:

- Reorient or relocate the receiving antenna.
- Increase the separation between the equipment and receiver.
- Connect the equipment into an outlet on a circuit different from that to which the receiver is connected.
- Consult the dealer or an experienced radio/TV technician for help.

Hunter Industries Incorporated • The Irrigation Innovators

Internet: www.HunterIndustries.com

INT-784

P/N 701013 06/09