

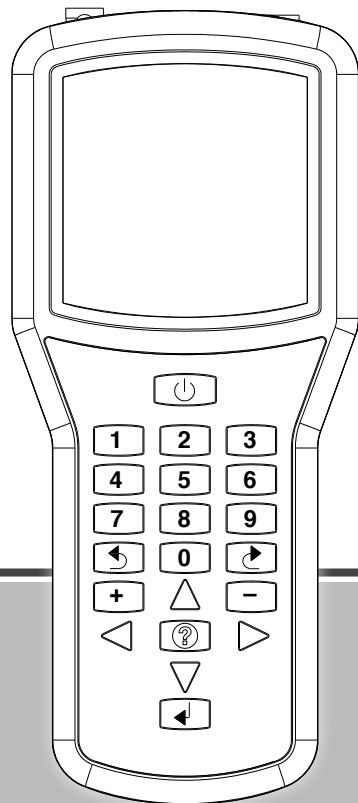

ICD-HP

Handheld Programmer for
Hunter ICD Decoders



Owner's Manual and Operating Instructions

Hunter[®]



Hunter®

Table of Contents

Introduction	3
ICD-HP Components	4
INSTALLING THE BATTERIES	6
KEYPAD FUNCTIONS	7
CABLE AND LEAD CONNECTIONS	8
CONNECTING TO A DECODER	9
Operations	11
ICD-HP SETUP	12
• LCD Settings	12
• Set Languages	12
• Set Units of Measure.....	12
• Current Dec Versions.....	13
DECODER PROGRAMMING MENU	13
• Get Decoder Info	14
• Program a Decoder	15
• Get Decoder Status	20

Table of Contents

DECODER FIRMWARE	23
• Update Dec Firmware.....	23
DIAGNOSTICS	25
• Turn Station On/Off	25
• Get Decoder Status	27
• Test Sensors.....	28
• Multimeter.....	38
ICD-HP Flash Update	39
Troubleshooting	41
Specifications	42
FCC Notice	43
Industry Canada Notice	44
CE & Australia Notice	45

Introduction

The ICD-HP Handheld Programmer is an innovative setup, programming, and diagnostic tool for Hunter ICD series decoder products.

This instrument can operate and program ICD decoders via wireless induction, through the base of the decoder, with a special programming cup. This allows access to installed decoders, without removing waterproof wire connectors.

ICD-HP can also be used for initial setup of new decoders. The included power leads will power a decoder for programming purposes, for installation later.

ICD-HP can be used for diagnostic operation and testing of installed decoders, solenoids, and even sensors.

ICD-HP can enable new programming options for ICD decoders. It can program any station numbers in any order within a multi-station decoder and can “skip” stations to reserve them for future use.

ICD-HP Components

ICD-HP is packaged with required accessories.

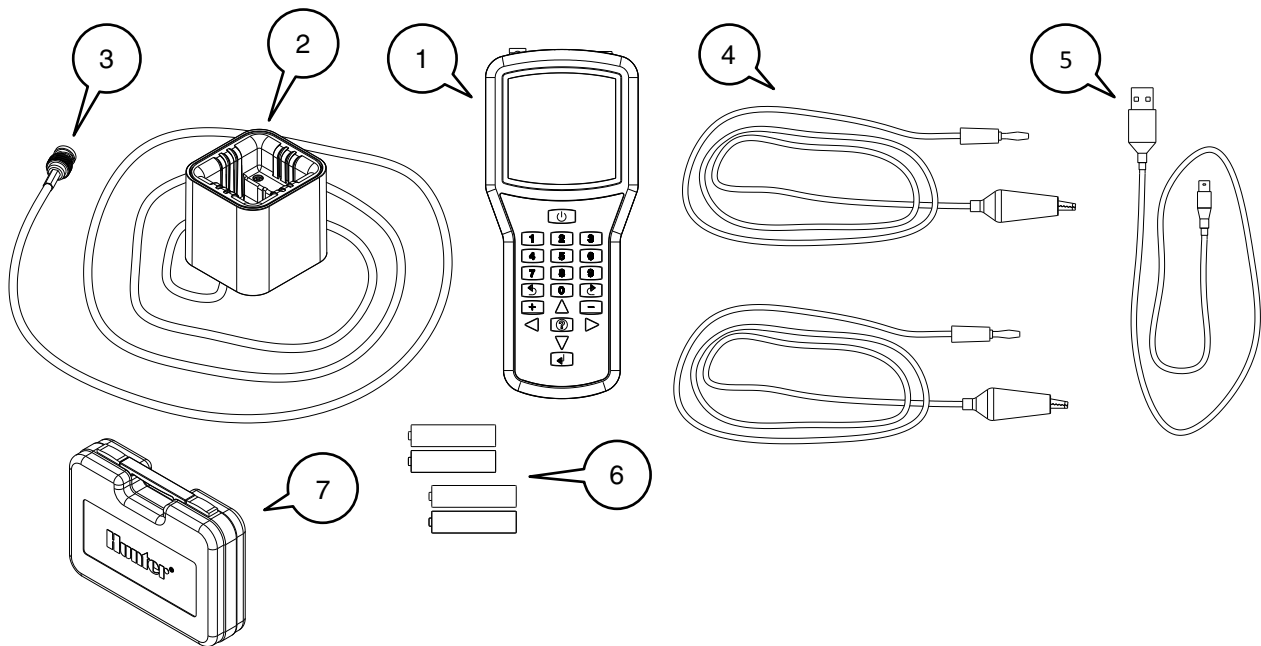

Item	Part	Description
1	----	ICD-HP Programmer
2	177600	Programming Cup
3	180504	Programming Cable 6' (2 m) with connectors
4	180508	Red and Blue 6' (2 m) leads
5	----	USB A to mini-A 3' (1 m) cable
6	----	4 x AA batteries
7	205800	Carrying Case

The Programming Cable is NOT a standard BNC connector cable and cannot be replaced with a standard coaxial BNC cable. This item is unique to the ICD-HP programmer. Do not attempt to use the ICD-HP programming cable for any other purpose!

INSTALLING THE BATTERIES

The ICD-HP programmer operates with 4 x AA batteries. The batteries supplied are not rechargeable!

To install batteries:

Remove cables and connectors from end of ICD-HP.

Pry the yellow flexible yellow boot off the ICD-HP.

Turn the ICD-HP over, and remove the 2 screws securing the battery compartment cover with a small screwdriver (either standard or Philips).

Insert 4 fresh AA batteries as shown, observing polarity.

Replace cover with screws and secure.

Replace yellow boot.

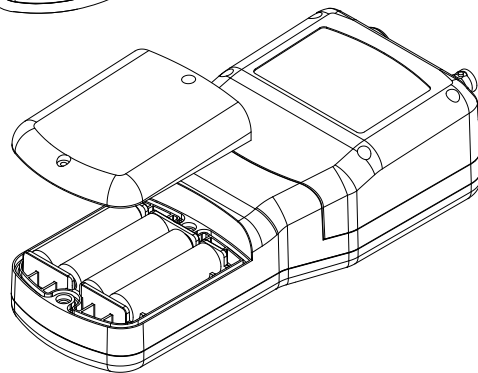
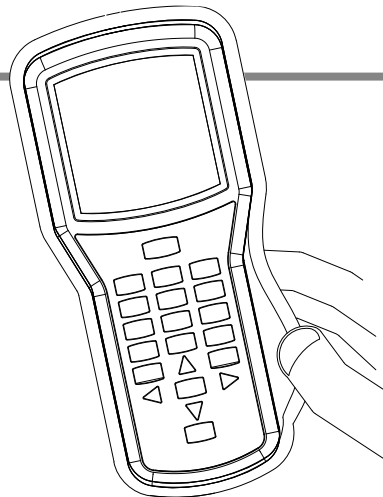

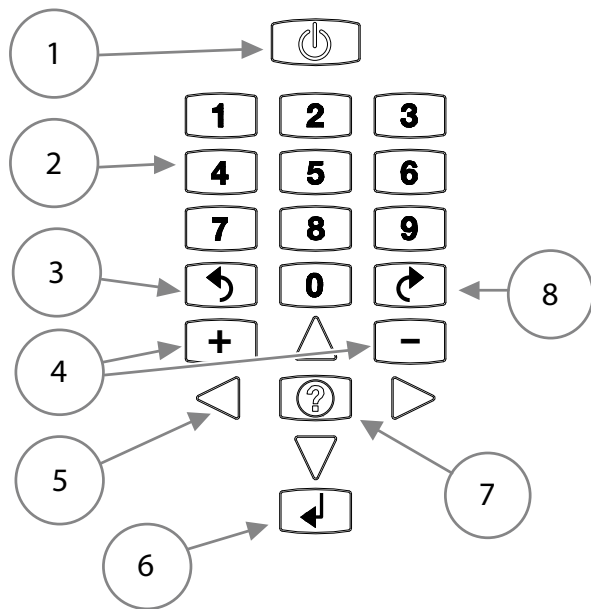

KEYPAD FUNCTIONS

1. **Power button**
2. **Number buttons:** Used to enter station numbers and other numeric data.
3. **Back button:** Returns to previous menu.
4. **Plus and Minus (+/-) buttons:** Used to change station numbers, and also to turn stations On (+) and Off (-).
5. **Arrow buttons:** Used to navigate within screens, move pointers, or change outputs on multi-station decoders.
6. **Enter:** Used mostly to retry certain functions.
7. **Question/Info:** Used to switch pages in some screens. Also used to enter ICD-HP flash mode.
8. **Next button:** Used to select a menu item and go to the next level. Also used to execute certain commands.

CABLE AND LEAD CONNECTIONS

USB: The supplied USB cable will power the ICD-HP from a laptop or desktop computer port.

Connect the larger USB A connection to a standard computer USB.

Unscrew the blue protective cap over the ICD-HP's USB port on the end of the programmer.

Connect the mini-USB to the ICD-HP. Do not force the connector the wrong way!

Replace the protective cap when this port is not in use, to prevent water damage.

Any standard USB to mini-USB cable will work as a replacement.

Red and Blue Leads: Connect the straight connectors by pushing all the way into the matching colored plugs.

Programming Cable: Keep the cable connectors clean and free of mud and dirt! Connect both ends before placing the cable in a valve box or other dirty location.

Connect either end of the cable to the connector on the ICD-HP. Align connector slots with female connector on programmer, push straight in, and turn 90 degrees until the connector locks into place.

Connect the other end of the Programming Cable to the Programming Cup in the same way.

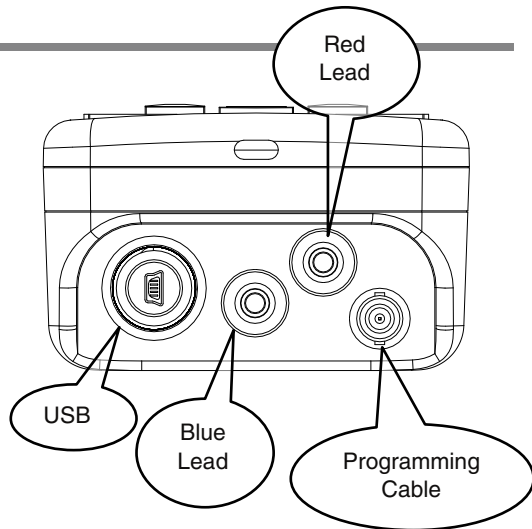

CONNECTING TO A DECODER

The ICD-HP programmer works with Hunter ICD and later decoders. The ICD-HP programming cup communicates with decoders through wireless induction.

The bottom end of the decoder (opposite the end with the wires) is the receiver area for the signals from the programming cup.

The entire inside of the cup is within the wireless range, and it is not necessary to press decoders firmly in place, as long as they are within the cup. The programming cup does have pockets for the two different sizes of decoder, and these will help hold the cup and decoder together firmly in field applications.

Bench Mode (If the decoder is uninstalled, and not connected to the two-wire path):

Install the red and blue wire leads for the ICD-HP.

Connect the programming cup to the ICD-HP.

Clip the red and blue leads to the decoder red and blue leads.

Place the decoder in the programming cup.

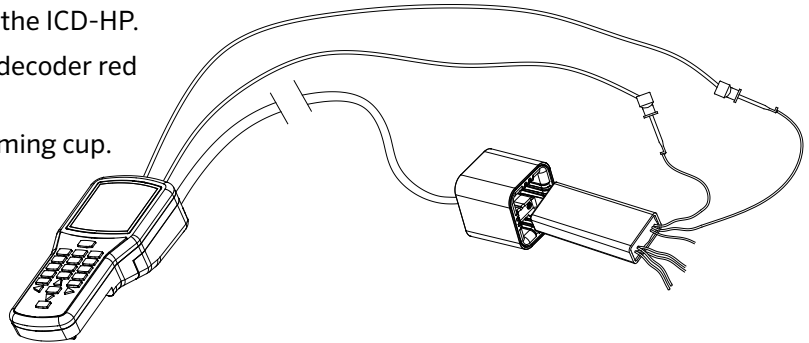

Field Mode: If the decoder is installed in the two-wire path, it is not necessary to disconnect any decoder wiring. Connect the programming cup to the ICD-HP with the programming cable.

Wipe mud and dirt off the decoder to prevent wear on the programming cup and interference with the signal.

Seat the programming cup over the decoder. The bottom of the decoder (the end with no wires) should be within the programming cup.

Verify that the two-wire path is connected to the controller, and that controller power is on.

The decoder will be powered over the two-wire path, and the red and blue ICD-HP leads will not be necessary.

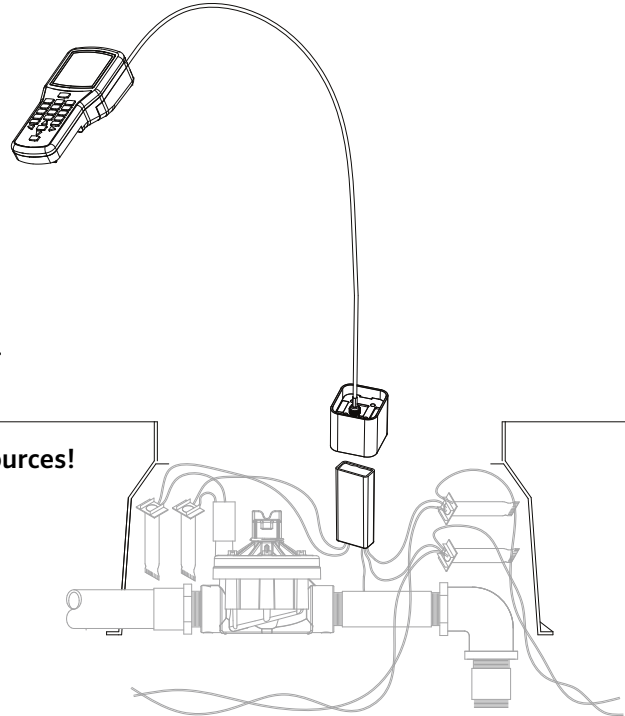

Protect the ICD-HP from sprinkler spray and other water sources!

Operations

Turn the programmer on with the power button. The logo will appear and change to the Main Menu in a few seconds.

MAIN MENU AND NAVIGATION

For the first use, or to change general settings, select ICD-HP Setup from the Main Menu.

Most menu selections throughout ICD-HP operate with the same buttons. Use the arrow keys to navigate around the screens. Use the + and - buttons to change the choices in settings. Use the Next ↻ button to select an option, and go to the next screen. Use the Back ↶ button to exit and return to the previous level.

In some selections, the Enter button ↵ is used to make selections.

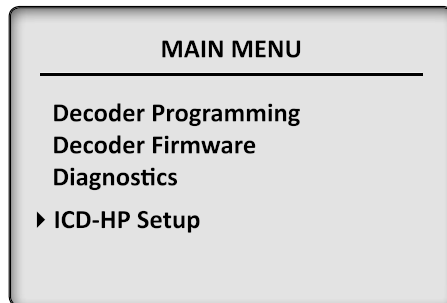

ICD-HP SETUP

LCD Settings

Adjust screen appearance with Contrast, Backlight, and Backlight Timeout controls. Use the arrow buttons to move to the item you wish to change, and press the + or - button to adjust the settings.

Increasing the contrast and backlight can improve visibility in low light conditions, but will also consume batteries more quickly. The backlight will turn off automatically after a period of no use. The time is selectable under Backlight Timeout controls, or the backlight can be turned off to preserve battery life.

Set Languages

Select operating system language of your programmer.

Use the up/down arrow keys to set the pointer to your selection.

Use the Next  button to make the selection, and the display will show the selection.

Press the Back  button to exit.

Set Units of Measure

Change between English and Metric readings (GPM or LPM).

Use the up/down arrow keys to set the pointer to your selection.

Use the Next  button to make the selection, and the display will show the selection.

Press the Back  button to exit.

ICD-HP SETUP MENU

- ▶ LCD Settings
- Set Language
- Set Units
- Current Dec Versions
- ICD-HP Info

Current Dec Versions

Shows the current versions of decoder firmware loaded into ICD-HP. If you flash update a decoder's operating system, this is the version that will be loaded.



The current decoder version may be updated when the ICD-HP operating system is flash updated.

ICD-HP Info: Displays current versions of the ICD-HP operating system and circuitry.

DECODER PROGRAMMING MENU

Install a decoder with either method in the "Connecting to a Decoder" section on page 9.

Note: The programming cup is used for all Decoder Programming Menu functions.

From the Main Menu, use the arrow keys to point to Decoder Programming and press the Next  button. The Decoder Programming Menu will appear. Use the arrows to move the pointer to any function and press Next  to select it.

DECODER PROGRAMMING MENU

- ▶ Get Decoder Info
- Program Decoder
- Get Decoder Status

DECODER INFO

Dec Type: 2-Station
Output #: 1
Station #: 007
Serial #: #####
◀ / ▶ Change OUTPUT #
Press ? For More

DECODER INFO

Dec Type: 2-Station
Pwr Factor: 2
Inrush: 5
Serial #: #####
Version: 1.01.005
Press ? To Return

Get Decoder Info

Get Decoder Info will check the decoder and display its current settings. It will not change any of the settings in the decoder. It can be used to identify the station number(s) and other settings of any ICD or later decoder.

Dec Type: Shows if the decoder is a Station decoder (and the number of stations), Pump decoder, or Sensor decoder.

Output #: If the decoder is a multi-station decoder, the display only shows the station address of one output at a time. Each color-coded pair of wires from the decoder is a different output.

Press the left and right arrow buttons to move through the different outputs, and view the station numbers for each output.

Decoder Info has a second “page” for further information about the decoder’s setting. Press the ? button for “More”. The second page will show the Power Factor, Inrush setting, and Version number of the decoder firmware. Press ? again to return to the first page.

Serial numbers are not used to address decoders, except in older Hunter decoder controllers (IDS, Genesis and VSX “Viking” decoder systems). Serial numbers cannot be changed.

DECODER INFO

Dec Type: 2-Station
Output #: 2
Station #: 008
Serial #: #####
◀ / ▶ Change OUTPUT #
Press ? For More

DECODER INFO

Dec Type: Sensor
Address: 1
Serial #: #####
Version: 1.02.000
Press ? For Ports

SENSOR DECODER 1

Port A Type: Flow
HFSFCT200
Port B Type: Klik™

Sensor Decoder Info: If the decoder is a sensor decoder, the screen will show information for the decoder on the first page. Press ? to see specific information for the Port settings.

The second page will show how each sensor port has been configured. If a Flow Sensor has been configured for Port A, the sensor type will also be shown.

Program a Decoder

Program Decoder will enter the station addresses and other settings of the decoder.

Move the pointer with the arrow buttons at the Main Menu screen to Program Decoder and press Next ↻.

The ICD-HP will check for a decoder. If successful, it will display the Dec Type, Power Factor, and Inrush information for the decoder after a few seconds.

Dec Type: Press the + and - buttons to change the decoder type. It is possible to change a station decoder to Pump, to assign it to one of the P/MV (Pump/Master Valve) outputs for the controller. It is best to use a single-station decoder for a P/MV output. If a multi-station decoder is set to Dec Type Pump, the other outputs can no longer be used, and will be wasted.

If the Dec Type shown is “Sensor,” the ICD-HP is reading a Sensor Decoder and the Dec Type cannot be changed.

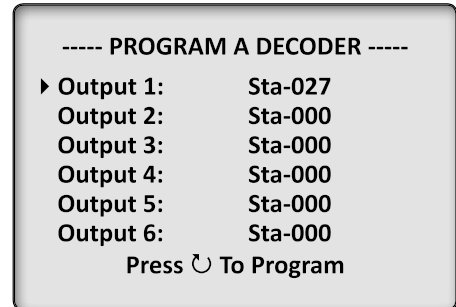
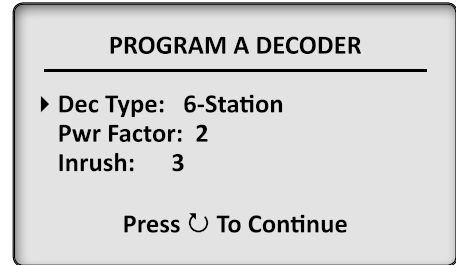

Pwr Factor: Power Factor. Default setting is 2 and this is the recommended setting. The Power Factor can be increased for certain high current requirements (such as Pump Start Relays), but this can degrade performance for other stations on the line. Change only when required.

Inrush: This can change the inrush timing for the station or relay when first turning on. The best general Inrush setting is 5. Some heavy duty devices may require a higher inrush setting. Consult Hunter Technical Support before changing the Inrush value.

Press Next  to continue.

Assign Station Numbers: The next screen will show the station number assigned to each decoder output. The number of outputs is based on the decoder's size. A single station decoder (ICD-100) will only show one output. A two-station decoder (ICD-200) will show two output lines, etc.

Use the up and down arrows to move the pointer to each output. Use the number keys to type the controller station number you wish to assign to each output. Or use the + and - keys to raise and lower the station numbers.

If you have already assigned a station number to an output, using the + and - buttons to change another output will skip over any station number that has already been assigned.

Example: Output 1 is assigned Sta-007. When setting Output 2, using the +/- buttons will skip 007 and move directly from 006 to 008.

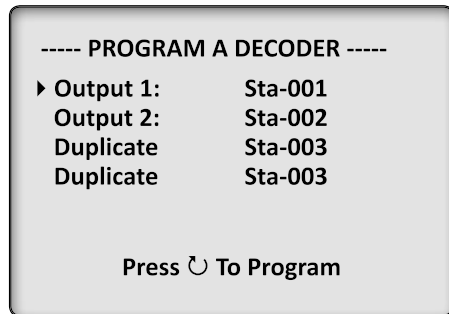

Flashing "Duplicate" shows duplicate station numbers. Change address before programming.

If numbers are entered directly from the keypad, it may temporarily permit a duplicate, but this will not be sent to the decoder. If a duplicate station number is entered in a multi-station decoder, and the Next  button is pressed, the ICD-HP will refuse to send the program until the duplicate numbers have been changed.

The outputs with duplicate numbers will flash “Duplicate”, alternating with the output numbers.

Pump: If the Dec Type was changed to Pump (instead of a station decoder), only Output 1 will be shown. Use + and - to change between P/MV-1 and P/MV-2 (P/MV = Pump/Master Valve).

Programming: When all settings are made and outputs are numbered (see Important Notes section), press the Next  button to send the station numbers to the decoder.



The display will show “Programming...” for a short time. If successful, “Programming Complete” will appear after the program has been sent.

Decoder Comm Unsuccessful: This message indicates that the programming was not successful. Most likely causes are the connections or the decoder power. Check power leads to the decoder, programming cup cable connections, and verify there is power on the two-wire path from the controller (if programming in line).

Turn Line Power Off, and Back On: After programming or re-programming installed decoders, the two-wire path power must be turned off for 15 seconds, and then back on, for the programming to take effect in the field.

PROGRAM A DECODER

!COMM UNSUCCESSFUL!
Check connections.
Check decoder power.

Press  To Re-Try
Press  To Exit

The station numbers will be in the decoder's memory, but the power must be cycled (off/on) to take effect. You can turn off power to the controller, or remove the ADM99 output module from the controller, and then plug it back in after 15 seconds.

IMPORTANT NOTES:

Outputs may be assigned from 000 to 500. Do not assign a station number higher than the capacity of your controller, or it will not operate! (Example: ACC99D has 99 station capacity. Do not program a station number higher than 99). The ICD-HP does not know the capacity of your controller.

Reserved Stations: It is possible to assign "000" to a decoder output with the ICD-HP. This output will not be used. However, it may be programmed at a later date, to add a new station to a multi-station decoder.

For example, a six-station decoder could have output #6 (or any other outputs) set to station 000. The 000 outputs would not be operational, but could be reserved for future additions. Then the new station number could be assigned to the reserved 000 output with the ICD-HP.

Do not assign a station 000 unless you wish to skip a station, or reserve one for future expansion. Station number 000 cannot be turned on by a controller.

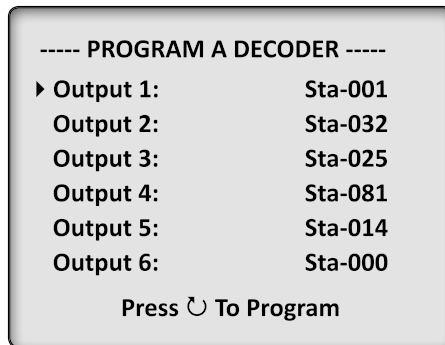

Sample ICD-600 display with random station numbers and Output 6 held in reserve (000).

Stations in Random Order: It is possible to assign any valid station numbers in any order. The ICD-HP can enter any station numbers in a multi-station decoder in any order. This cannot be done from the controller's decoder programming, but is an added feature with ICD-HP.

Do not assign duplicate addresses! No decoder controller should have duplicate station numbers, anywhere within the entire system. (This does not apply to station 000, however.)

The ICD-HP will not allow duplicate station numbers within a single decoder, but it cannot detect duplicates elsewhere in the system.

Sensor Decoder Programming (ICD-SEN): If the decoder in the programming cup is an ICD-SEN sensor decoder, only the address can be set. The Dec Type will be Sensor, and this cannot be changed when a sensor decoder is found.

Choose an address between 1-5 with the + or - button, and press Next  to send to the sensor decoder.

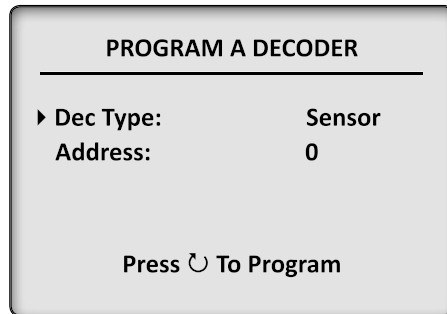

Turn Line Power Off, and Back On: After programming or re-programming installed decoders, the two-wire path power must be turned off for 15 seconds, and then back on for the programming to take effect in the field.

Other Sensor Decoder set up options are made at the controller, and not from the ICD-HP. Consult controller and/or sensor decoder documentation for complete setup instructions.



Get Decoder Status

Connect to any decoder to view status, for identification and diagnostics. This can be used with either installed decoders, or disconnected decoders that are powered through the ICD-HP power leads.

From the Main Menu, select Decoder Programming with the Next  button. Move the pointer with the up/down arrows to Get Decoder Status, and press Next  again to select. The ICD-HP will attempt to communicate with the decoder.

When a decoder is found, the status will be displayed.

Station Decoders: If the decoder is a Station Output decoder, the display will show the following information.

Dec State: Can be Normal, Fault, or Damaged.

Normal: Decoder is responding correctly.

Fault: Decoder output wires are shorted or solenoid coil is shorted. This does not indicate a problem with the decoder! Check field wiring and solenoid.

Damaged: There is a problem with the decoder, and it should be replaced. Damaged indicates the decoder is “leaking” voltage on the outputs when it should be off.

DECODER STATUS						
Dec State:	Normal					
Current:	167mA					
Output #:	1	2	3	4	5	6
Solenoid:	Y	Y	Y	Y	Y	N
Active :	Y	Y	Y	Y	N	N

Normal Decoder has 5 solenoids detected, with 4 stations running (Active).

Decoder comm unsuccessful: This may indicate a complete decoder failure, OR the decoder may not be connected or powered properly. Verify ALL connections: ICD-HP to programming cup (both ends) and decoder power. If the decoder is connected in the two-wire path but the controller power is Off, decoder will not respond. If decoder and ICD-HP are connected correctly, and decoder has power, and Decoder comm unsuccessful message appears, the decoder may be defective.

Current: Displays electrical current draw of decoder in milliamps. Standby range is approximately 3-5 mA. When decoder is active, this value will be higher, depending on Power Factor, number and type of devices connected to decoder output. Total current on a decoder cannot exceed 1000 mA.

The current display does not change in real time. If a station is started or stopped, run the diagnostic Get Decoder Status again to see the new current draw.

Output: The output matrix shows the status of each output of the decoder. The display will show the number of outputs for the size of decoder detected (a single station decoder will only have 1 output).

Solenoid: Shows whether a solenoid or similar device is detected on the output (Y=Yes, N=No).

The Solenoid status may not change until power has been cycled off/on to the decoder, if a solenoid has just been added to the decoder. Turn off either the controller, or remove the ADM99 decoder output module from the controller, for approximately 15 seconds, and then turn the power back on (or replace the ADM99). Solenoid status will be updated.

The Solenoid status line may not be visible in early versions of the decoder firmware. These older decoders may be flash updated with the ICD-HP, if you need to see the Solenoid status. Future versions may also show the Voltage as a separate line in this display. See Decoder Firmware section, page 23.

The Solenoid status line may not be visible in early versions of the decoder firmware. These older decoders may be flash updated with the ICD-HP, if you need to see the Solenoid status. Future versions may also show the Voltage as a separate line in this display. See Decoder Firmware section, page 23.

Active: Shows whether the output is currently turned on (Y=Yes, N=No).

Sensor Decoders: If the decoder found during Get Decoder Status is a Sensor Decoder, the display will show the status of each sensor input to the decoder's Ports, on individual screens. Use the left and right arrows to see each Port (A and B) individually.

Clik Sensors: The display will show the current state of the Clik input as Closed (normal) or Open (alarmed).

Flow Sensors: The display will show the type of flow sensor (set from the controller), the size or K-Factor and Offset, and the current actual flow in GPM or LPM (depending on Unit of Measurement settings).

The ICD-HP is not used to set or change flow sensor settings. It shows what the controller has sent to the sensor decoder, and displays the current flow.

The flow sensor is always connected to Port A of the sensor decoder. Use the left and right arrows to view Port B, which can be used for Clik sensor inputs.

The flow reading will update changes in flow live, in the screen display, as valves open and close.

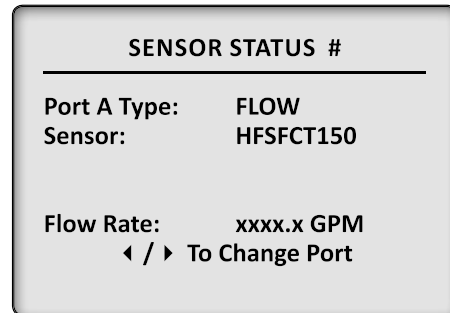
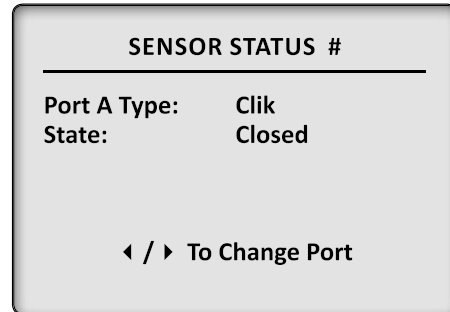

DECODER FIRMWARE

The decoder firmware menu checks and has the ability to update a decoder's operating system (firmware). Updating will take approximately 2.5 minutes, and must not be interrupted once it has begun.

The programming cup is required for all functions in the Decoder Firmware menu. Make sure batteries have enough charge to complete the procedure.

From the Main Menu, use the up/down arrows to move the pointer to Decoder Firmware and press Next . The display will show two options, Get Decoder Ver and Update Dec Firmware.

Update Dec Firmware: Move the pointer to Update Dec Firmware and press Next . This will display the "Latest Version" loaded into the ICD-HP, and display it above the version found in the decoder. If the versions are different, you have the option to load the latest version into the decoder.

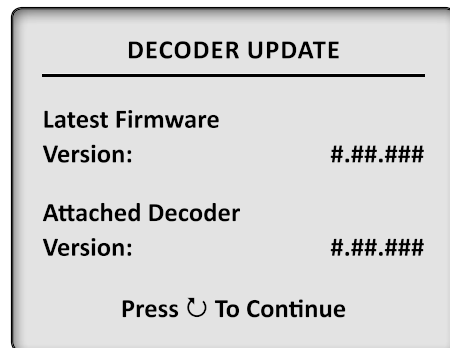
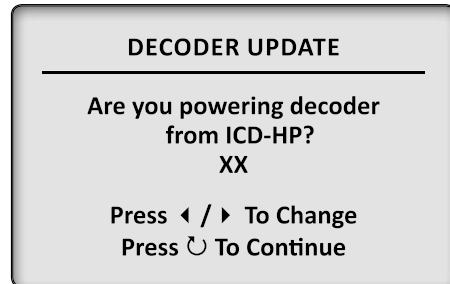

Note: The “Latest Firmware Version” is loaded into the ICD-HP operating system. This can be updated, if new firmware is released, by re-flashing the ICD-HP itself from a computer. The updates will contain both station decoder and sensor decoder firmware versions for the decoders.

If the version in the decoder is older than the version loaded into the ICD-HP, and you wish to update the decoder, press Next ↻.

A warning message will appear. Do not continue unless you will be able to complete the process.

Continuing with the update will put the decoder into a “bootload” mode. The decoder will not function until the update is complete. If you are sure, press Next ↻ again to continue, and the firmware update will begin. A status bar will show the progress of the download.

It will take approximately 2.5 minutes to update a decoder’s firmware.

Do not disconnect the decoder during this update! The firmware update should always be allowed to complete, once it has begun. If the update is interrupted, exit and restart the “Update Dec Firmware” function.

DECODER UPDATE

Beyond this point,
Decoder will not
function until update
is completed

Press ↻ To Continue

DECODER UPDATE

Update Progress...



DECODER UPDATE

!Complete!

Dec Type:	X-Station
Station #:	###
Serial #:	#####
Version:	###.###

The update will not erase the decoder output station addresses. If the decoder is used as a Pump, this information will also be retained.

If the decoder is a Sensor Decoder, it will automatically receive the Sensor Decoder firmware, and the address and port settings will be retained.

A status screen will announce when the update is complete, and verify the new version number.

DIAGNOSTICS

The Diagnostics menu allows operation and test of decoder functions, along with some sensor and controller test functions.

From the Main Menu, move the pointer to Diagnostics and press Next ↻.

Turn Station On/Off

The ICD-HP can turn individual station outputs on and off for diagnostic purposes (see special note for IDS and Viking systems). This function only works with decoders wired into the two-wire path, and will not operate when powered by the leads from the ICD-HP.

TURN STATION ON/OFF

Output #:	1
Station #:	###
Serial #:	#####
State:	xxx

◀ / ▶ To Change Output #
+ On / - Off

Note: ICD-HP can activate a station, but it will not turn on the Pump/Master Valve outputs for that station (if applicable). If the station requires a Pump/Master Valve for operating pressure, turn this on separately from the controller (or turn on another station that triggers the Pump/Master Valve, with a remote control).

Connect a decoder with the programming cup. Move the pointer to the Turn Station On/Off and press Next ↻.

The ICD-HP will first connect to the decoder and display the first station output. If the decoder is a multi-station decoder, use the left and right arrow buttons to move to the station to turn on or off.

Press + to turn a station on. The station will run for approximately 1 minute if running alone, or 12 minutes if another station is running from the controller (see Important Notes in this section). The State will change from Off to On after a few seconds.

If the station is connected to a pressurized valve, the water will turn on. Take care to keep the ICD-HP out of the water from sprinklers.

Press - to turn a station off. The station will turn off and the State will change from On to Off after a few seconds.

Important Notes: The ICD-HP cannot set a run time for a decoder activation. The ACC controller will send an Off command down the two-wire path once per minute when no stations are supposed to be running. If you turn a station on with the ICD-HP, this controller command will turn that station back off within a minute.

If longer run times are required for diagnostic purposes, turn another decoder station on from the ACC controller or with a remote control (ICR, ROAM, or Maintenance Radio). As long as this station is running from the controller, the “off” command will not be sent every minute.

If another station is running from the controller as described, and a station in the field is turned on with the ICD-HP, it will run for approximately 12 minutes or until it is turned off from the ICD-HP.

Special Note for IDS and “Viking” systems: These earlier decoder controllers can operate ICD decoders via serial numbers. In these systems, there may not be station numbers programmed directly into the ICD decoders because those controllers do not use them. If you wish to activate stations in these systems from ICD-HP, program temporary station numbers into the decoder from the Decoder Programming menu. Turn the controller power off for approximately 15 seconds, then turn the power back on to allow the station address to set permanently in memory. The Turn Station On and Off commands will then work.

The ICD-HP will not work with older Viking style decoders, only with ICD decoders installed in Viking type systems.

Get Decoder Status

This allows quick access to the same status matrix for outputs as the Get Decoder Status command from the Decoder Programming menu.

This can be used to view the current draw of a solenoid after it has been turned on with the Turn Station On/Off command from the ICD-HP. Turn the station or multiple stations on, then use Get Decoder Status to view the current draw on the decoder.

Test Sensors

Test Sensors leads to two categories of tests: 1) tests for Klik™ sensors, and 2) tests for Flow Sensors.

Test Klik Sensor Output: To test any Klik sensor or switch closure device, disconnect the sensor from the controller or sensor decoder. This test does not require the programming cup. The ICD-HP test leads are connected directly to the sensor outputs.

Note: This diagnostic test does not use the programming cup. The test leads are connected directly to the Klik sensor output wires.

From the Diagnostics menu, select Test Sensors.

Move the pointer to Klik Sensor and press Next ↻.

Move the pointer to Klik Output Tester and press Next ↻.

The on-screen instructions will state “Connect Klik sensor to blue and red leads on ICD-HP.” Connect one of the leads to each of the sensor’s click outputs and press Next ↻.

The ICD-HP will check and display the state of the sensor as Open or Closed. If the sensor state is changed with a switch or sensor test button, the screen will show the new state.

SENSOR OUTPUT TEST

Sen Status: Closed

Set The Sensor To
Open The Contacts

SENSOR OUTPUT TEST

Sen Status: Open

Release The Sensor To
Close The Contacts

Test Klik Sensor Input (Controller or Sensor Decoder): This diagnostic will test the Klik inputs to either an ICD-SEN sensor decoder, or a sensor input terminal in a Hunter controller.

From the Diagnostics menu, select Test Sensors.

Move the pointer to Klik Sensor and press Next ↻.

Move the pointer to Klik Simulator and press Next ↻.

The display will show the Unit Under Test selection. With the pointer set to Unit Under Test, use + and - to switch between “Controller” and “Decoder”.

Controller Input: With Unit Under Test set to Controller, connect the red (+) and blue (-) leads from the ICD-HP directly to the + and - SEN terminals in the controller and press Next ↻. Make sure the correct polarity is used (red to +, blue to -).

The display will show the current sensor status. Press + or - to open or close the sensor and observe the results at the controller. This simulates a Klik input to the controller and verifies whether the sensor input is working.

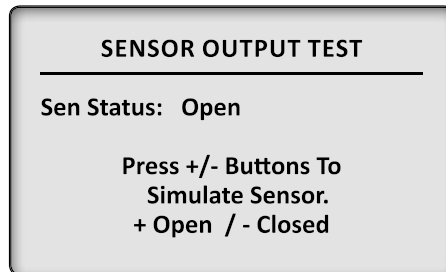
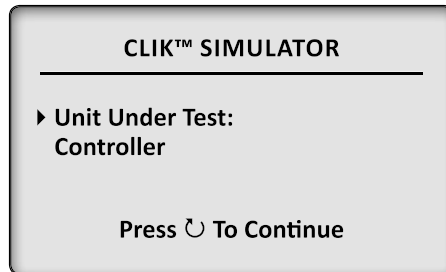

Decoder Input: Set Unit Under Test to Decoder (only for ICD-SEN sensor decoders). The screen will then show the Sensor Port (A or B).

Select Port: Move the pointer to the Sensor Port location and use + or - to change between Sensor Port A and B.

Note: Sensor Port A is the purple-and-white wire pair from the ICD-SEN, and can be either a Klik or a Flow sensor input. Sensor Port B is the orange-and-white wire pair, and can only be used as a Klik input.

Ports must be connected with the correct polarity (red lead to + port wire, blue lead to - port wire). Port wire polarity is marked on the decoder. The wires on the front of the decoder (with the Address label) are the negative or - lead after the loops are cut.

Select the port you wish to test and press Next ↻.

The display will prompt you to first connect the sensor leads, and then insert the ICD-SEN into the programming cup. Press Next ↻ after each step.

CLIK™ SIMULATOR

▶ **Unit Under Test:**
Decoder

Sensor Port: A

Press ↻ To Continue

CLIK™ SIMULATOR

Sen Status: Open

Dec Status: Open

Press +/- Buttons To
Simulate Sensor.
+ Open / - Closed

The ICD-HP will communicate with the decoder and show the current status of the sensor.

“Sen Status” shows the sensor setting of the ICD-HP.

“Dec Status” shows the input state (Open or Closed) as seen by the decoder. There may be a slight delay before Dec Status is updated (this may show “?????” before it is updated), while the ICD-HP waits for the sensor decoder’s response.

Press + and - to change between Open and Closed sensor settings. This will simulate a switch opening and closing.

If the Sen Status is set to Closed, and the Dec Status remains Open:

- Check to make sure the ICD-HP is connected to the right port (A or B).
- Check the connection of the ICD-HP leads to the sensor decoder.
- Check the sensor decoder configuration using the Get Dec Info function in the Decoder Programming Menu.

With the leads properly connected and the correct port selected, if Sen Status and Dec Status remain in disagreement, the sensor decoder input may be defective.

Touch the sensor port wires together as an alternative test.

Flow Output Tester: To test the output of any HFS flow meter, or compatible “Other” flow meter such as IR220B, disconnect the flow sensor’s signal wires from the controller or sensor decoder.

Note: This diagnostic test does not use the programming cup. The test leads are connected directly to the flow sensor output wires.

From the Diagnostics menu, select Test Sensors.

Move the pointer to Flow Output Tester and press Next .

The on-screen instructions will state “Connect flow sensor to blue and red leads on ICD-HP. Note lead polarity.”

Connect the red (+) ICD-HP lead to the positive (usually red) wire from the flow sensor. Connect the blue (-) ICD-HP lead to the negative (usually black) wire from the compatible flow sensor. Press Next .

Set the Sensor type: For Hunter HFS flow sensors, use the + and - buttons to select the correct sensor. For “Other” sensors, select Other and the K-Factor, and Offset settings will appear. Use the arrow buttons to move the pointer to each value, and set the K-Factor and Offset to match the sensor manufacturer’s documentation for the pipe size and type. Use the numbers on the keypad to enter the values.

FLOW TEST MENU

- ▶ Flow Output Tester
- Flow Simulator

SENSOR OUTPUT TEST

- ▶ Sensor: HFSFCT200
- Sample Avg: 5 Sec

Press  To Test

FLOW OUTPUT TEST

- ▶ Sensor: OTHER
- K-Factor: xxxx.xx
- Offset: yy.yy
- Sample Avg: 5 Sec

Press  To Test

Sample Average sets the amount of time for the rolling average flow. The default setting is 5 seconds, which is recommended. To see minor variations in flow, use the + or - buttons to set a shorter sample time. To see a more controlled average with fewer fluctuations, set a higher sample time.

When the settings are correct for the meter you wish to test, press Next ↻.

The screen will show both the sensor frequency and the calculated gallons or liters per minute (see ICD-HP Setup menu to change Units of Measurement). The sensor frequency shows the actual click output of the sensor. The Flow Rate shows the estimated (calculated) flow for the sensor settings, based on the click rate of the sensor.

Flow Simulator (Flow Input Tester): This test may be used with either a sensor decoder, or a Hunter controller flow input directly (such as ACC Flow terminals on the controller master module). The programming cup is required when using it with a sensor decoder.

Note: ICD-HP is only designed for Hunter controller flow sensor inputs and is not tested with or designed for other brands of controllers.

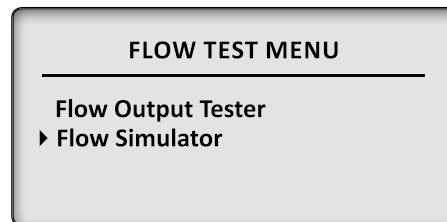
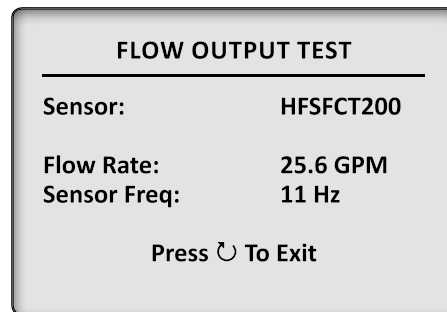

From the Diagnostics menu, select Test Sensors.

Move the pointer to Flow Sensor and press Next ↻.

Move the pointer to Flow Simulator and press Next ↻.

The display will show the Unit Under Test selection. With the pointer set to Unit Under Test, use + and - to switch between “Controller” and “Decoder”.

Controller Input: This will test the flow sensor input to a Hunter controller. The programming cup is not used for this test. The test leads will be connected directly to the controller’s flow input terminals.

With Unit Under Test set to Controller, connect the red (+) and blue (-) leads from the ICD-HP directly to the matching polarity Flow Sensor terminals in the controller and press Next ↻.

Set the Sensor type to match the setting in the controller to be tested with the + and - buttons. If the type is Other, the K-Factor and Offset settings will appear. Enter the calibration factors to match the controller settings and the sensor manufacturer’s documentation. Use the numbers on the keypad to enter the values.

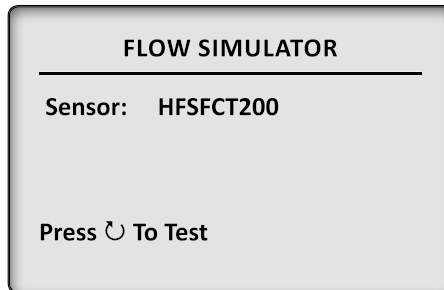
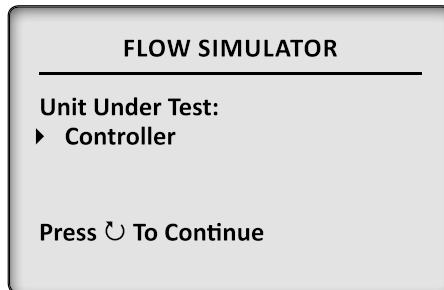

When the sensor selection is correct, press Next ↻.

The display will show the default click rate as “Test Freq”. Use the + and - button or number keys to change the click rate to any desired setting.

The Calc Rate will show the estimated (calculated) flow for the sensor settings, based on the click rate.

Check the controller flow display to verify that the flow rate is approximately the same. Due to variations in components, flow readings are unlikely to match exactly between the ICD-HP and the controller. They should be within a reasonable range.

As the Test Freq rate is changed on the ICD-HP, the readings on the controller should also change to approximately match the calculated rate. Allow the controller a few seconds to catch up to ICD-HP changes, as they read a rolling average.

If no flow input is detected at the controller with the test in progress, verify that the controller has a flow meter configured, and that the location setting is for “Controller”.

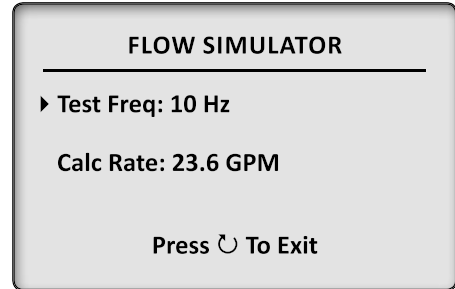

Decoder Input: This will test the flow sensor input to a Hunter sensor decoder, and the programming cup will be required. The controller's flow sensor should be set to "Location: ADM" for flow to be read via a sensor decoder.

With Unit Under Test set to Decoder, press Next ↻. The screen will prompt the correct connections.

Connect the programming cup to the sensor decoder, with the decoder powered on the two-wire path. Press Next ↻.

Connect the red and blue leads from the ICD-HP directly to the Flow Sensor leads on the sensor decoder. The leads must be connected with red to positive (+) and blue to negative (-) because this is a DC signal. Flow input polarity is marked on the sensor decoder label. Press Next ↻.

The Sensor type setting will be read from the sensor decoder. This cannot be changed at this screen because the ICD-HP is reading the configuration information from the sensor decoder.

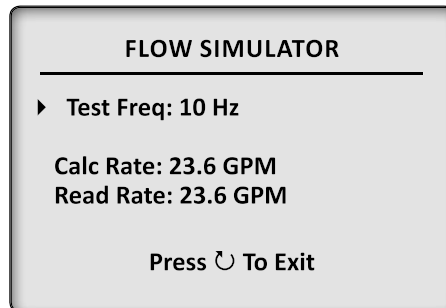
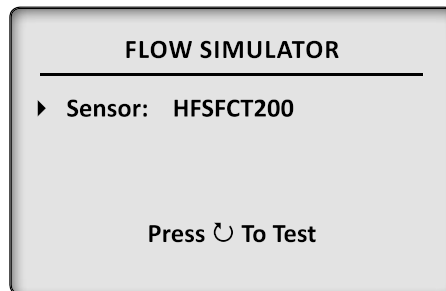

The flow simulation will begin with the pointer set to the Test Freq rate of 10 Hz. The test frequency can be changed with the + or - buttons during the test, or a new frequency can be typed in directly from the numeric keypad.

The “Calc Rate” is the estimated flow calculation, based on the sensor settings and the click rate (frequency). The “Read Rate” is the value from the output of the sensor decoder to the controller.

When the test frequency rate is changed, the calculated rate will change immediately. The read rate will increase more slowly, as the rolling average increases, but will display the new rate after a few seconds. Generally, the output of the sensor decoder will match the flow rate shown at the controller very closely.

Check the flow at the controller, to verify that it is similar to the flow Read Rate from the sensor (on the ICD-HP).

If no flow is detected on the ICD-HP in Read Rate, check the polarity of the sensor leads.

If no flow is detected at the controller with the test in progress, check the Sensor Decoder configuration information.

Multimeter

The ICD-HP can function as a voltmeter for decoder line voltage. The ICD-HP is designed to measure 50V or less, and is not designed for high voltage measurements. The meter is protected with a resettable circuit breaker, but avoid contact with primary AC power lines (120/230 VAC).

The multimeter function can be used to verify the presence of voltage on the two-wire path, and to measure whether a long path of unknown length still has sufficient voltage ($\geq 20V$) to activate solenoids.

This measurement does not use the programming cup. The wire leads are connected directly to the two-wire path.

From the Diagnostics menu, move the pointer to Multimeter and press Next \curvearrowright .

The display will show Dec Line Voltage. Press Next \curvearrowright .

Connect the blue and red leads from the ICD-HP to the blue and red wires on the two-wire path and press Next \curvearrowright .

The line voltage will be displayed. This display will not show the pulsing that is characteristic of decoder line voltage, but will show the average peak voltage. Some minor fluctuation of voltage within a volt is normal. The voltage will change as the decoder output turns on and off.

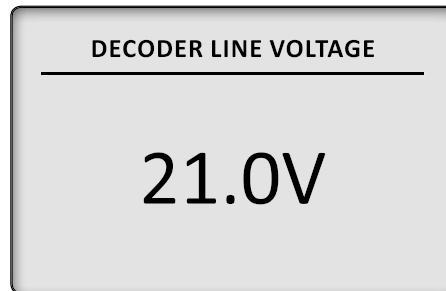

ICD-HP Flash Update

The programmer itself may be updated after purchase. Hunter Industries may release firmware updates, and these can be used to overwrite or “re-flash” the ICD-HP operating system. This can add new features, or install a newer version of decoder firmware for updating decoders.

Flash updates may be emailed or downloaded. Once received, they must be installed on a computer first. Consult the documentation that accompanies the update program for the correct procedure.

To prepare the ICD-HP for update:

Turn the ICD-HP off with its power button.

Connect the ICD-HP to the computer with the USB cable, while holding in the ? button.

Continue holding the ? button until the display appears and says “DO NOT DISCONNECT - PLEASE WAIT”.

Start the update installer on the computer.

When the update begins, a progress bar will appear in the ICD-HP display. This update may take several minutes.

Do not interrupt the update. Allow it to finish completely. The progress bar will fill in, to show approximate status of the update.

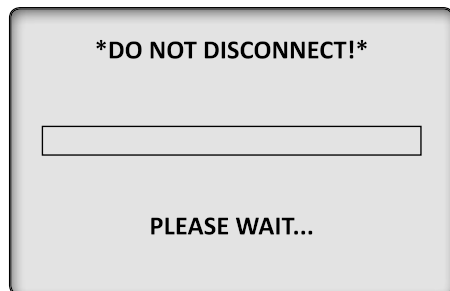

The ICD-HP will restart when the update is finished. The Hunter logo will appear and the new version number will be visible in the display.

Note: If the update software is not started within 2 minutes, the ICD-HP will time out of update mode. The “DO NOT DISCONNECT – PLEASE WAIT” message will disappear, and the ICD-HP will return to normal operating mode or turn off if the operating system update was not completed.

You may restart the update mode at any time.

Turn the ICD-HP off with the power button.

Press and hold the ? button, and turn the ICD-HP power on with the power button. Continue holding the ? button until the display re-appears and says “DO NOT DISCONNECT – PLEASE WAIT”. The ICD-HP will now be in flash update mode again.

Troubleshooting

PROBLEM	CAUSES	SOLUTIONS
<p>ICD-HP will not communicate with decoder.</p> <p>“Comm Unsuccessful”</p>	<p>No power to decoder.</p> <p>Decoder Programming cup disconnected.</p> <p>Batteries low.</p> <p>Decoder is damaged.</p>	<p>Check controller power to two-wire path, or connect power leads to decoder.</p> <p>Check Programming Cup connection to decoder and ICD-HP.</p> <p>Check battery display or retry with USB power if available.</p>
<p>Stations will not turn on.</p>	<p>No solenoid connected.</p> <p>Decoder is powered from ICD-HP power leads.</p> <p>No power on two-wire path.</p> <p>Master Valve not on (station solenoid is on, but no water).</p> <p>Decoder is in IDS/Viking control system.</p>	<p>Check solenoid connections.</p> <p>Station activation not possible.</p> <p>Check two-wire path and controller power.</p> <p>Start station with MV from controller or remote.</p> <p>Program dummy station numbers into decoder.</p>
<p>Decoder will not respond after firmware update.</p>	<p>Stuck in bootloader mode.</p>	<p>Repeat firmware update steps and allow to complete.</p>
<p>Poor battery life.</p>	<p>Display backlight will reduce battery life.</p>	<p>Reduce timer or turn off backlight display.</p> <p>Use USB power whenever possible.</p> <p>Do not leave CliK™ Output Tester or Flow Output Tester functions active, or connected to sensor.</p>

Specifications

Operating Specifications

Station Number Range: 001- 500
(blank outputs are set to "000")

Sensor Decoder Address Range: 001- 005

Max Cable length to Programming Cup: 6 ft (2 m)

Max Range of Induction Signal: 1" (2.54 cm) from
end of programming cup.

Electrical Specifications

Battery Power: 4 x AA batteries

USB Power: 5 VDC, 300 mA

USB Connections: USB A to mini-B connector

Voltage Limit (red/blue leads): 60 VAC, Max

Weight

ICD-HP only: 1.4 lbs (0.63 kg)

Complete in Case: 4.8 lbs (2.1 kg)

Dimensions, Programming Cup

Height: 2.375" (6 cm)

Width: 2.375" (6 cm)

Depth: 2.625" (6.6 cm)

Dimensions, ICD-HP

Height: 8.25" (21 cm)

Width: 3.875" (9.8 cm)

Depth: 2.1875" (5.5 cm)

FCC Notice

FCC ID: M3UICDHP

This device complies with FCC rules Part 15. Operation is subject to the following two conditions:

- This device may not cause harmful interference and
- This device must accept any interference received, including interference that may cause undesired operation

This equipment has been tested and found to comply with the limits for class B digital devices, pursuant to part 15 of the FCC Rules. These limits are designed to provide reasonable protection against harmful interference in a residential installation.

This equipment generates, uses, and can radiate radio frequency energy and if not installed and used in accordance with the instructions, may cause harmful interference to radio communications. However, there is no guarantee that interference will not occur in a particular installation. If this equipment does cause harmful interference to radio or television reception, which can be determined by turning the equipment on and off, the user is encouraged to try to correct the interference by one or more of the following measures:

- Reorient or relocate the receiving antenna
- Increase the separation between the equipment and the receiver
- Connect the equipment to an outlet on a circuit different from that to which the receiver is connected
- Consult the dealer or an experienced radio/TV technician for help

The user is cautioned that changes and modification made to the equipment without the approval of the manufacturer could void the user's authority to operate this equipment.

Industry Canada Notice

IC: 277A-ICDHP

Operation is subject to the following two conditions:

- This device may not cause harmful interference and
- This device must accept any interference received, including interference that may cause undesired operation.

Note: This device has been designed to only operate with programming cup antenna PN 205700 available from Hunter Industries Inc. Do not attempt to substitute any other device.

CE & Australia CE Notice

Hunter Industries hereby declares that this remote control device is in compliance with the essential requirements and other relevant provisions of Directive 1999/5/CE.

Declaration of Conformity: We, Hunter Industries Incorporated, 1940 Diamond Street, San Marcos, CA 92078, declare under our own responsibility that the ICD Handheld Programmer, model ICD-HP to which this declaration refers, conforms with the relevant standards:

Emissions: ETSI EN 300 330-2 V1.3.1
 ETSI EN 300 330-1 V1.3.1

Immunity: ETSI EN 301 489-1 V1.8.1
 ETSI EN 301 489-3 V1.4.1

Signature: 	
Place: San Marcos, CA	Full Name: Peter Woytowitz
Date: MAY 5 th , 2009	Position: Engineering Manager



RESIDENTIAL & COMMERCIAL IRRIGATION | *Built on Innovation®*

1940 Diamond Street, San Marcos, California 92078, USA

Learn more. Visit hunterindustries.com

© 2019 Hunter Industries Incorporated

LIT-512 6/19